



MIC5210

Dual 100mA LDO Regulator

Advance Information

General Description

The MIC5210 is a dual linear voltage regulator with very low dropout voltage (typically 10mV at light loads and 140mV at 100mA), very low ground current (225 μ A at 10mA output), and better than 3% initial accuracy. It also features individual logic-compatible enable/shutdown control inputs.

Designed especially for hand-held battery powered devices, the MIC5210 can be switched by a CMOS or TTL compatible logic signal, or the enable pin can be connected to the supply input for 3-terminal operation. When disabled, power consumption drops nearly to zero. Dropout ground current is minimized to prolong battery life.

Key features include current limiting, overtemperature shutdown, and protection against reversed battery.

The MIC5210 is available in 3.0V, 3.3V, 3.6V, 4.0V and 5.0V fixed voltage configurations. Other voltages are available; contact Micrel for details.

Features

- Micrel Mini 8™ MSOP package
- Guaranteed 100mA outputs
- Low quiescent current
- Low dropout voltage
- Wide selection of output voltages
- Tight load and line regulation
- Low temperature coefficient
- Current and thermal limiting
- Reversed input polarity protection
- Zero off-mode current
- Logic-controlled electronic enable

Applications

- Cellular telephones
- Laptop, notebook, and palmtop computers
- Battery powered equipment
- Bar code scanners
- SMPS post regulator/dc-to-dc modules
- High-efficiency linear power supplies

Ordering Information

Part Number	Voltage	Accuracy	Junction Temp. Range*	Package
MIC5210-3.0BMM	3.0	1.0%	-40°C to +125°C	8-lead MSOP
MIC5210-3.3BMM	3.3	1.0%	-40°C to +125°C	8-lead MSOP
MIC5210-3.6BMM	3.6	1.0%	-40°C to +125°C	8-lead MSOP
MIC5210-4.0BMM	4.0	1.0%	-40°C to +125°C	8-lead MSOP
MIC5210-5.0BMM	5.0	1.0%	-40°C to +125°C	8-lead MSOP

Other voltages available. Contact Micrel for details.

Typical Application

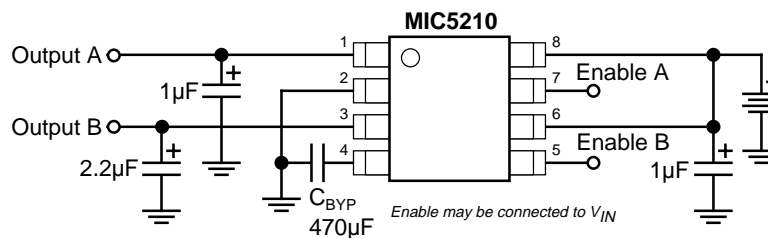

Low-Noise + Ultralow-Noise (Dual) Regulator

MM8 and Micrel Mini 8 are trademarks of Micrel, Inc.

Pin Configuration

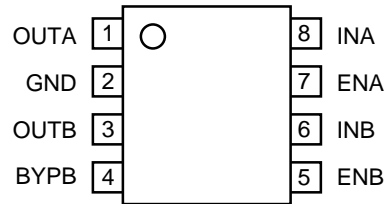

MIC5210BMM

Pin Description

Pin Number	Pin Name	Pin Function
1	OUTA	Regulator Output A
2	GND	Ground: Both pins must be connected together.
3	OUTB	Regulator Output B
4	BYPB	Reference Bypass B: Connect external 470pF capacitor to GND to reduce output noise in regulator "B". May be left open.
5	ENB	Enable/Shutdown B (Input): CMOS compatible input. Logic high = enable, logic low or open = shutdown. Do not leave floating.
6	INB	Supply Input B
7	ENA	Enable/Shutdown A (Input): CMOS compatible input. Logic high = enable, logic low or open = shutdown. Do not leave floating.
8	INA	Supply Input A

Absolute Maximum Ratings

Supply Input Voltage (V_{IN})	–20V to +20V
Enable Input Voltage (V_{EN})	–20V to +20V
Power Dissipation (P_D)	Internally Limited
Storage Temperature Range	–60°C to +150°C
Lead Temperature (soldering, 5 sec.)	260°C

Recommended Operating Conditions

Supply Input Voltage (V_{IN})	2.5V to 16V
Enable Input Voltage (V_{EN})	0V to 16V
Junction Temperature (T_J)	–40°C to +125°C
8-lead MSOP (θ_{JA})	Note 1

Electrical Characteristics

$V_{IN} = V_{OUT} + 1V$; $I_L = 100\mu A$; $C_L = 1.0\mu F$; $V_{EN} \geq 2.0V$; $T_J = 25^\circ C$, **bold** values indicate $-40^\circ C \leq T_J \leq +125^\circ C$; unless noted.

Symbol	Parameter	Conditions	Min	Typical	Max	Units
V_O	Output Voltage Accuracy	variation from specified V_{OUT}	-1 -2		1 2	% %
$\Delta V_O/\Delta T$	Output Voltage Temperature Coefficient	Note 2		40		ppm/ $^\circ C$
$\Delta V_O/V_O$	Line Regulation	$V_{IN} = V_{OUT} + 1V$ to 16V		0.004	0.012 0.05	% / V % / V
$\Delta V_O/V_O$	Load Regulation	$I_L = 0.1mA$ to 150mA (Note 3)		0.02	0.2 0.5	% %
$V_{IN} - V_O$	Dropout Voltage, Note 4	$I_L = 100\mu A$ $I_L = 50mA$ $I_L = 100mA$ $I_L = 150mA$		10 110 140 165	50 70 150 230 250 300 275 350	mV mV mV mV mV mV
I_{GND}	Quiescent Current	$V_{EN} \leq 0.4V$ (shutdown) $V_{EN} \leq 0.18V$ (shutdown)		0.01	1 5	μA μA
I_{GND}	Ground Pin Current, Note 5	$V_{EN} \geq 2.0V$, $I_L = 100\mu A$ $I_L = 50mA$ $I_L = 100mA$ $I_L = 150mA$		80 350 600 1300	125 150 600 800 1000 1500 1900 2500	μA μA μA μA μA μA μA
PSRR	Ripple Rejection	frequency = 100Hz, $I_L = 100\mu A$		75	500	dB
I_{LIMIT}	Current Limit	$V_{OUT} = 0V$		320	500	mA
$\Delta V_O/\Delta P_D$	Thermal Regulation	Note 6		0.05		%/W
e_{no}	Output Noise	$I_L = 50mA$, $C_L = 2.2\mu F$, 470pF from BYP to GND		260		$nV\sqrt{Hz}$

ENABLE Input

V_{IL}	Enable Input Logic-Low Voltage	regulator shutdown			0.4 0.18	V V
V_{IH}	Enable Input Logic-High Voltage	regulator enabled	2.0			V
I_{IL}	Enable Input Current	$V_{IL} \leq 0.4V$ $V_{IL} \leq 0.18V$		0.01	-1 -2	μA μA
I_{IH}		$V_{IH} \geq 2.0V$ $V_{IH} \geq 2.0V$		5	20 25	μA μA

Note 1: Absolute maximum ratings indicate limits beyond which damage to the component may occur. Electrical specifications do not apply when operating the device outside of its operating ratings. The maximum allowable power dissipation is a function of the maximum junction temperature, $T_{J(max)}$, the junction-to-ambient thermal resistance, θ_{JA} , and the ambient temperature, T_A . The maximum allowable power dissipation at any ambient temperature is calculated using: $P_{D(max)} = (T_{J(max)} - T_A) \theta_{JA}$. Exceeding the maximum allowable power dissipation will result in excessive die temperature, and the regulator will go into thermal shutdown. The θ_{JA} of the 8-lead MSOP (MM) is 200 $^\circ C/W$ mounted on a PC board (see "Thermal Considerations" section for further details).

Note 2: Output voltage temperature coefficient is defined as the worst case voltage change divided by the total temperature range.

Note 3: Regulation is measured at constant junction temperature using low duty cycle pulse testing. Parts are tested for load regulation in the load range from 0.1mA to 150mA. Changes in output voltage due to heating effects are covered by the thermal regulation specification.

Note 4: Dropout Voltage is defined as the input to output differential at which the output voltage drops 2% below its nominal value measured at 1V differential.

Note 5: Ground pin current is the regulator quiescent current plus pass transistor base current. The total current drawn from the supply is the sum of the load current plus the ground pin current.

Note 6: Thermal regulation is defined as the change in output voltage at a time "t" after a change in power dissipation is applied, excluding load or line regulation effects. Specifications are for a 150mA load pulse at $V_{IN} = 16V$ for $t = 10ms$.

Typical Characteristics

Power Supply Ripple Rejection vs. Voltage Drop

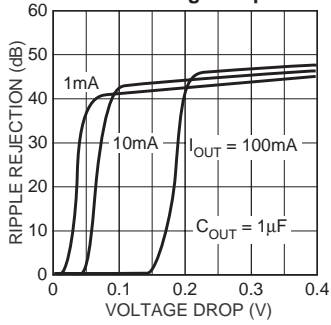

Turn-On Time vs. Bypass Capacitance

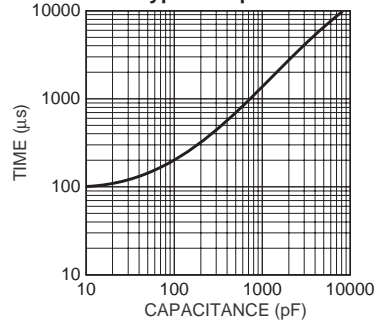

Dropout Voltage vs. Output Current

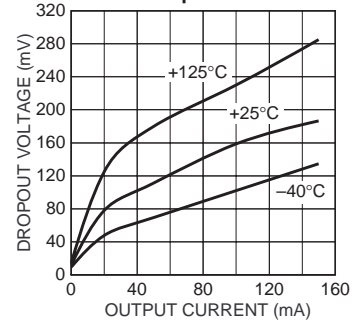

Power Supply Rejection Ratio

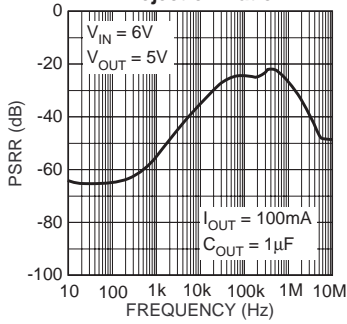

Power Supply Rejection Ratio

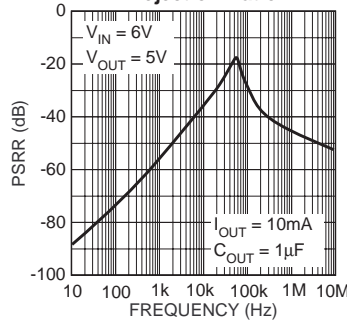

Power Supply Rejection Ratio

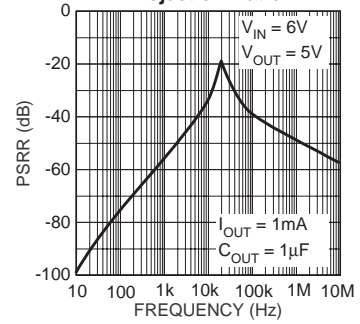

Power Supply Rejection Ratio

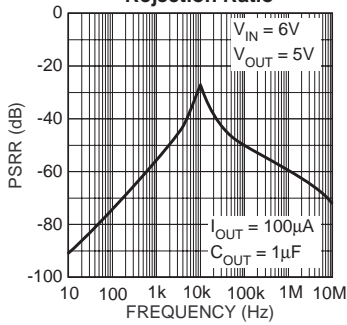

Noise Performance

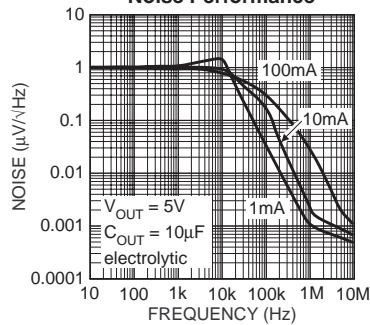

Noise Performance

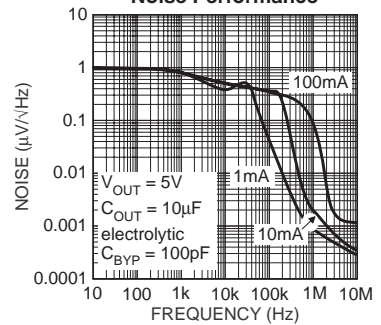

Applications Information

Enable/Shutdown

Forcing EN (enable/shutdown) high (> 2V) enables the regulator. EN is compatible with CMOS logic gates.

If the enable/shutdown feature is not required, connect EN to IN (supply input).

Input Capacitor

A 1μF capacitor should be placed from IN to GND if there is more than 10 inches of wire between the input and the ac filter capacitor or if a battery is used as the input.

Reference Bypass Capacitor

BYP (reference bypass) is connected to the internal voltage reference. A 470pF capacitor (C_{BYP}) connected from BYP to GND quiets this reference, providing a significant reduction in output noise. C_{BYP} reduces the regulator phase margin; when using C_{BYP} , output capacitors of 2.2μF or greater are generally required to maintain stability.

The start-up speed of the MIC5210 is inversely proportional to the size of the reference bypass capacitor. Applications requiring a slow ramp-up of output voltage should consider larger values of C_{BYP} . Likewise, if rapid turn-on is necessary, consider omitting C_{BYP} .

If output noise is not a major concern, omit C_{BYP} and leave BYP open.

Output Capacitor

An output capacitor is required between OUT and GND to prevent oscillation. The minimum size of the output capacitor is dependent upon whether a reference bypass capacitor is used. 1.0μF minimum is recommended when C_{BYP} is not used (see Figure 2). 2.2μF minimum is recommended when C_{BYP} is 470μF (see Figure 1). Larger values improve the regulator's transient response. The output capacitor value may be increased without limit.

The output capacitor should have an ESR (effective series resistance) of about 5Ω or less and a resonant frequency

above 1MHz. Most tantalum or aluminum electrolytic capacitors are adequate; film types will work, but are more expensive. Since many aluminum electrolytics have electrolytes that freeze at about -30°C, solid tantalums are recommended for operation below -25°C.

At lower values of output current, less output capacitance is required for output stability. The capacitor can be reduced to 0.47μF for current below 10mA or 0.33μF for currents below 1mA.

No-Load Stability

The MIC5210 will remain stable and in regulation with no load (other than the internal voltage divider) unlike many other voltage regulators. This is especially important in CMOS RAM keep-alive applications.

Dual-Supply Operation

When used in dual supply systems where the regulator load is returned to a negative supply, the output voltage must be diode clamped to ground.

Thermal Considerations

Multilayer boards having a ground plane, wide traces near the pads, and large supply bus lines provide better thermal conductivity.

The MIC5210-xxBMM (8-lead MSOP) has a thermal resistance of 200°C/W when mounted on a FR4 board with minimum trace widths and no ground plane.

PC Board Dielectric	θ_{JA}
FR4	200°C

MSOP Thermal Characteristics

For additional heat sink characteristics, please refer to Micrel Application Hint 17, "Calculating P.C. Board Heat Sink Area For Surface Mount Packages".

Package Information

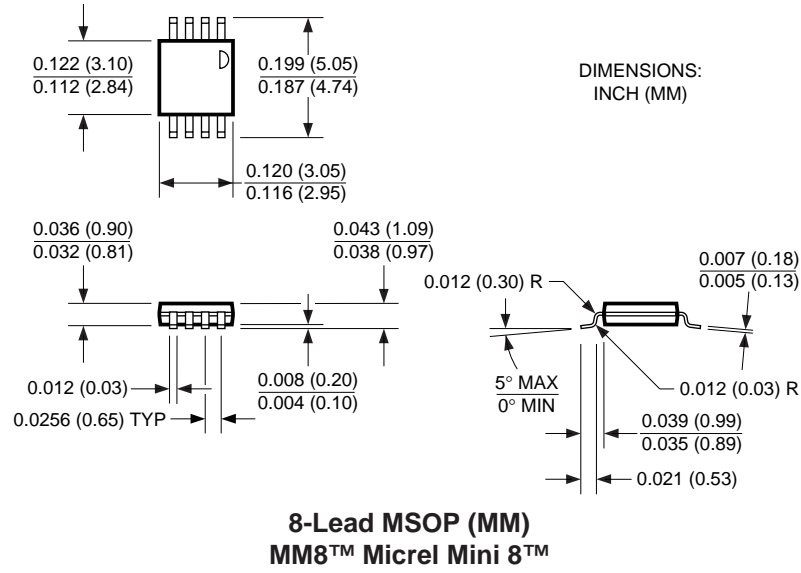

MICREL INC. 1849 FORTUNE DRIVE SAN JOSE, CA 95131 USA

TEL + 1 (408) 944-0800 FAX + 1 (408) 944-0970 WEB <http://www.micrel.com>

This information is believed to be accurate and reliable, however no responsibility is assumed by Micrel for its use nor for any infringement of patents or other rights of third parties resulting from its use. No license is granted by implication or otherwise under any patent or patent right of Micrel Inc.

© 1997 Micrel Incorporated